

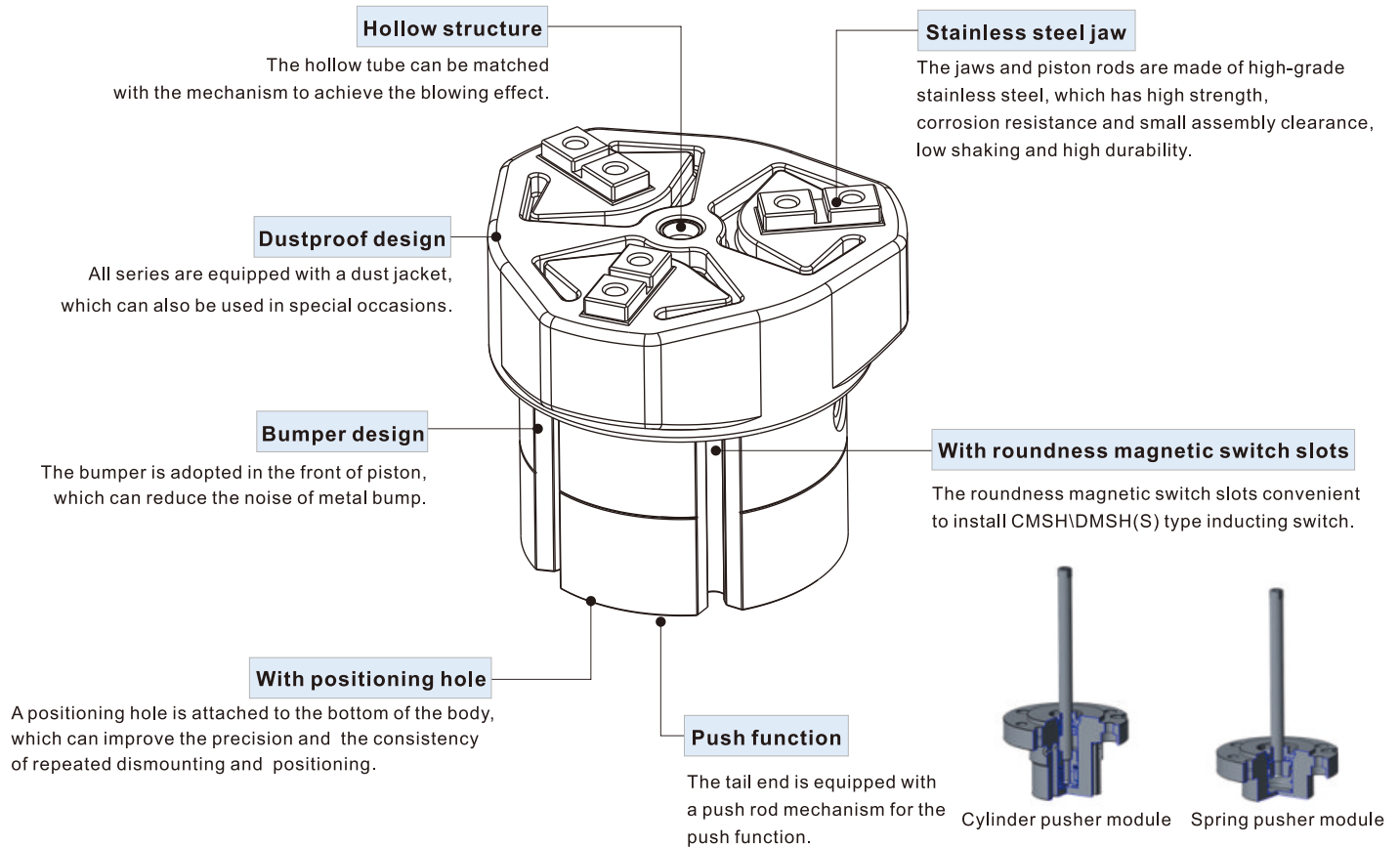

Air gripper—HFCQ Series

Parallel open/close hollow style

Compendium of HFCQ Series



Gripping force and stroke

Model	Gripping force per finger Effective valve(N)		Opening/Closing stroke (Both sides)(mm)	Weight (g)
	Internal	External		
HFCQ16	15	9	4	100
HFCQ20	26	21	4	140
HFCQ25	45	36	6	220
HFCQ32	77	62	8	430
HFCQ40	118	97	8	560
HFCQ50	187	155	12	950
HFCQ63	329	280	16	1600

Note) The gripping force in the above table is in the working pressure of 0.5MPa, and with a gripping point of L=20mm(Φ16~Φ25) or L=30mm(Φ32~Φ63).

Add) Please refer to page 437 for the definition of "L".

Installation and application



1. Dirty substances in the pipe must be eliminated before air gripper is connected with pipeline to prevent the entrance of impurities into the cylinder.
2. The medium used by cylinder shall be filtered to 40μm or below.
3. Anti-freezing measure shall be adopted under low temperature environment to prevent moisture freezing.
4. If the air gripper is dismantled and stored for a long time, pay attention to conduct anti-rust treatment to the surface. Anti-dust caps shall be added in air inlet and outlet ports.



Air gripper(parallel open/close hollow style)

HFCQ Series

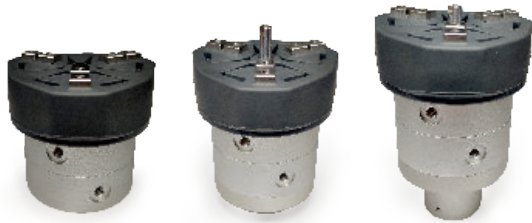

Specification

Bore size (mm)	16	20	25	32	40	50	63
Acting type	Double acting						
Fluid	Air(to be filtered by 40μm filter element)						
Operating pressure	0.2~0.7MPa(28~100psi)(2.0~7.0bar)			0.15~0.7MPa(22~100psi)(1.5~7.0bar)			
Temperature °C	-20~70						
Lubrication	Not required						
Repeatability mm	± 0.01						
Max. frequency	120(c.p.m)			60(c.p.m)			
Sensor switches	CMSH、DMSH(S)						
Port size	M3 × 0.5			M5 × 0.8			
Hollow diameter	Φ3 ^{+0.04} ₊₀	Φ3 ^{+0.04} ₊₀	Φ4 ^{+0.048} ₊₀	Φ6 ^{+0.04} ₊₀	Φ10 ^{+0.058} ₊₀	Φ12 ^{+0.07} ₊₀	Φ16 ^{+0.07} ₊₀
Push rod mechanism	-			Cylinder or Spring push rod mechanism			
Port size of push rod mechanism	-			M5 × 0.8			

[Note] Sensor switch should be ordered additionally. Refer to P519 for detail.

Symbol

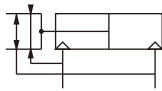

Product feature

1. The hollow tube can be matched with the mechanism to achieve the blowing effect.
2. The jaws and piston rods are made of high-grade stainless steel, which has high strength, corrosion resistance and small assembly clearance, low shaking and high durability.
3. All series are equipped with a dust jacket, which can also be used in special occasions.
4. A positioning hole is attached to the bottom of the body, which can improve the precision and the consistency of repeated dismounting and positioning.
5. The tail end is equipped with a push rod mechanism for the push function.
6. The sensor grooves of each specification are shared.

Ordering code

HFCQ 20 E

① Model					② Bore size		③ Push rod mechanism			
HFCQ: Air finger (Double acting, parallel hollow type)	16	20	25	32	40	50	63	Blank: Without push rod mechanism	E: Cylinder push rod mechanism	V: Spring push rod mechanism

Push rod mechanism ordering code

F-HFCQ 32 E

① Model		② Bore size		③ Push rod mechanism type		
HFCQ: Air finger (Double acting, parallel hollow type)	32	40	50	63	E: Cylinder push rod mechanism	V: Spring push rod mechanism

[Note]

1. The push rod mechanism can only be used with Φ32/Φ40/Φ50/Φ63.
2. HFCQ series are all attached with magnet.

Specification of Cylinder push rod mechanism

Model	HFCQ32E	HFCQ40E	HFCQ50E	HFCQ63E
Acting type	Double acting			
Fluid	Air(to be filtered by 40μm filter element)			
Operating pressure	0.2~0.7MPa(28~100psi)		0.15~0.7MPa(22~100psi)	
Temperature	-20~70 °C			
Lubrication	Not required			
Push stroke mm	7	8	14	15
Max. frequency	60(c.p.m)			
Sensor switches	DMSH(S)			
Push force N(0.5MPa)	45	130	204	335
Weight g	560	790	1350	2280

Specification of Spring push rod mechanism

Model	HFCQ32V	HFCQ40V	HFCQ50V	HFCQ63V
Push stroke mm	7	8	14	15
Push spring force N	5~12	9~18	16~31	24~40
Weight g	530	730	1270	2190

Air gripper(parallel open/close hollow style)

HFCQ Series

Inner structure and material of major parts

HFCQ32~63

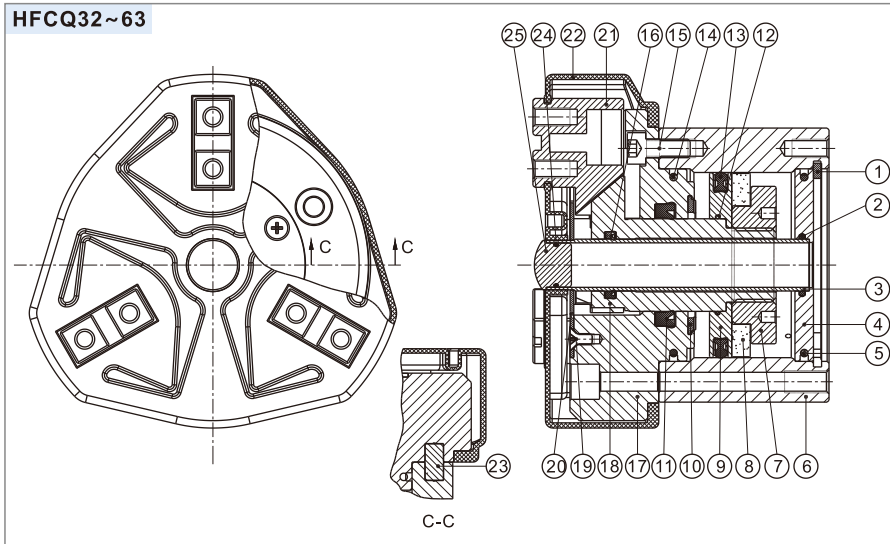

NO.	Item	Material
1	C clip	Spring steel
2	O-ring	NBR
3	Hollow tube	Stainless steel
4	Back cover	Aluminum alloy
5	O-ring	NBR
6	Body	Aluminum alloy
7	Magnet holder	Stainless steel
8	Magnet	Rare earths/Plastic
9	Piston	Aluminum alloy
10	Bumper	TPU
11	Rod packing	NBR
12	O-ring	NBR
13	Piston seal	NBR
14	O-ring	NBR
15	Countersink screw	Carbon steel
16	Rod packing	TPU
17	Front cover	Aluminum alloy
18	Piston rod	Stainless steel
19	Screw	Stainless steel
20	Cover blank	Stainless steel
21	Jaw	Stainless steel
22	Dustproof cover	NBR
23	Pin	Stainless steel
24	O-ring	NBR
25	Dustproof pluger	NBR

HFCQ32E~63E

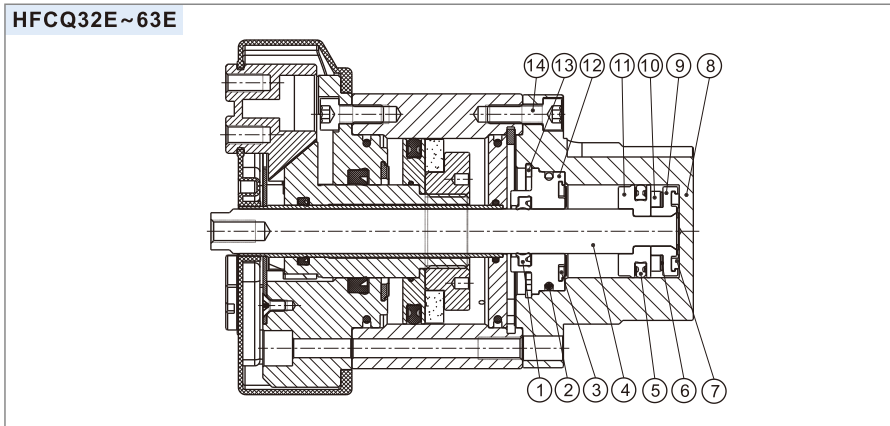

NO.	Item	Material
1	Rod packing	NBR
2	O-ring	NBR
3	Bumper	TPU/NBR
4	Push rod	Stainless steel
5	Piston seal	NBR
6	Magnet washer	NBR
7	Bumper	TPU/NBR
8	Body	Aluminum alloy
9	Magnet holder	Brass/Aluminum alloy
10	Magnet	Rare earths
11	Piston	Brass/Aluminum alloy
12	Front cover	Aluminum alloy
13	C clip	Spring steel
14	Countersink screw	Carbon steel

HFCQ32V~63V

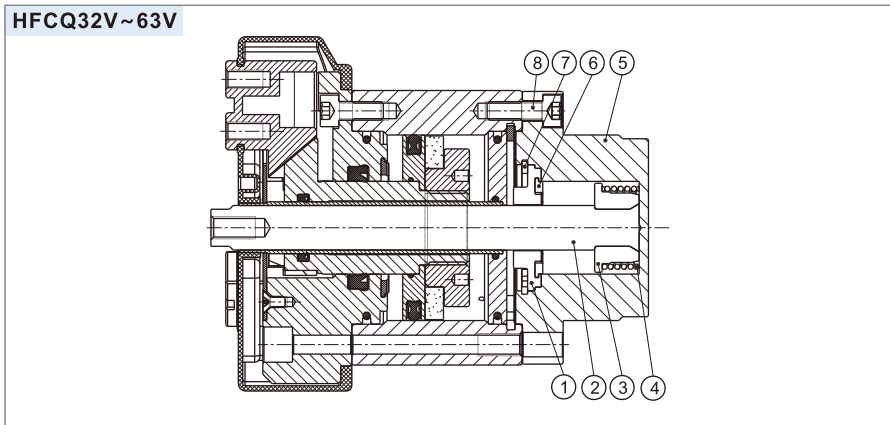

NO.	Item	Material
1	Front cover	Aluminum alloy
2	Push rod	Stainless steel
3	Piston	Aluminum alloy
4	Spring	SWPB
5	Body	Aluminum alloy
6	Bumper	TPU/NBR
7	C clip	Spring steel
8	Countersink screw	Carbon steel

Air gripper(parallel open/close hollow style)

HFCQ Series

Dimensions

HFCQ16~25

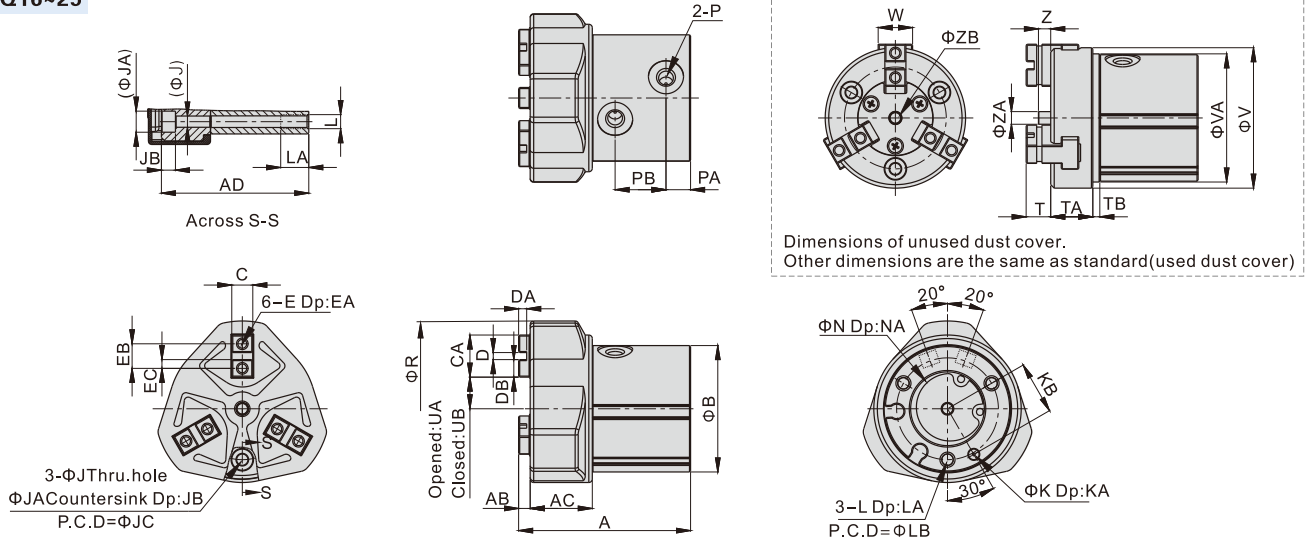

Bore size\Item	A	AB	AC	AD	B	C	CA	D	DA	DB	E	EA	EB	EC	J	JA	JB	JC	K	KA	KB	L	LA	LB
16	46	3	16	39	31	5 ^{+0.01} _{-0.03}	11	2 ^{+0.04} _{-0.01}	2 ^{+0.2}	4.5	M3×0.5	5	6	2	3.2	6	4	24	3 ^{+0.04} _{-0.01}	3	12	M4×0.7	8	24
20	49	3	18	42	36	6 ^{+0.01} _{-0.03}	12	2 ^{+0.04} _{-0.01}	2 ^{+0.2}	5	M3×0.5	5	7	2.5	3.2	6	4	29	3 ^{+0.04} _{-0.01}	3	15	M4×0.7	8	29
25	55	3	20	47	42	6 ^{+0.01} _{-0.03}	14	2 ^{+0.04} _{-0.01}	2 ^{+0.2}	6	M3×0.5	5	8	3	3.2	6	4	34	3 ^{+0.04} _{-0.01}	3	18	M4×0.7	8	34

Bore size\Item	N	NA	P	PA	PB	R	T	TA	TB	UA	UB	V	VA	W	Z	ZA	ZB
16	17 ^{+0.05}	1.5	M3×0.5	7	14	44	7	10.5	3	9	7	34	31.5	8	3.5	3.7	3 ^{+0.04}
20	21 ^{+0.05}	1.5	M5×0.8	7	14	50	7	12	3	10	8	40	36.5	10	3.5	3.7	3 ^{+0.04}
25	26 ^{+0.05}	1.5	M5×0.8	8	17	59	8	13	3	12.5	9.5	47	42.5	12	4.5	4.7	4 ^{+0.048}

HFCQ32~63

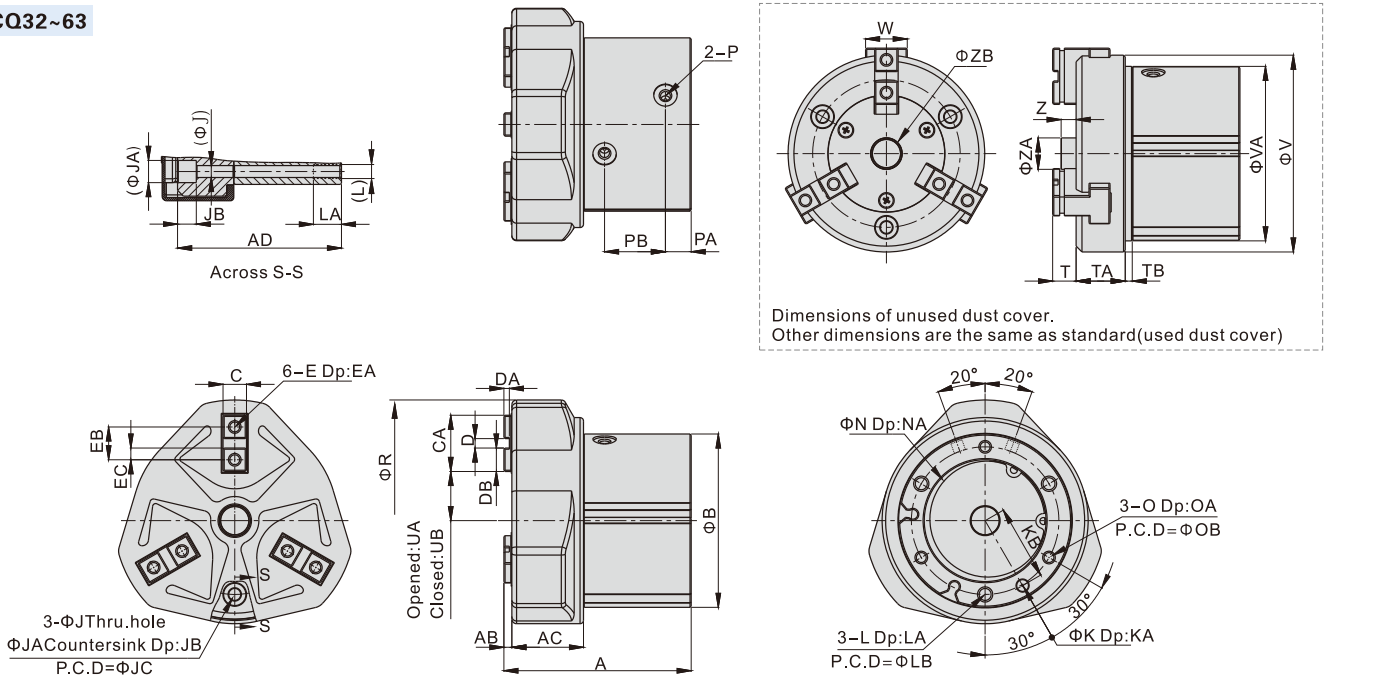

Bore size\Item	A	AB	AC	AD	B	CA	C	D	DA	DB	E	EA	EB	EC	J	JA	JB	JC	K	KA	KB	L	LA	LB	N	NA
32	63	3	24	54	55	20	8 ^{-0.03}	2 ^{+0.04}	2 ^{+0.2}	9	M4×0.7	8	11	4.5	4.2	8	7	44	4 ^{+0.04} _{-0.01}	4	22	M5×0.8	10	44	34 ^{+0.05}	2
40	66	3	26	57	62	21	8 ^{-0.03}	3 ^{+0.04}	2 ^{+0.2}	9	M4×0.7	8	12	4.5	4.2	8	7	52	4 ^{+0.04} _{-0.01}	4	26	M5×0.8	10	52	42 ^{+0.05}	2
50	80	3	31	70	74	24	10 ^{-0.03}	4 ^{+0.04}	2 ^{+0.2}	10	M5×0.8	10	14	5	5.1	9.5	8	63	5 ^{+0.04} _{-0.01}	5	32	M6×1.0	12	63	52 ^{+0.05}	2
63	91	4	37	79	92	28	12 ^{-0.03}	6 ^{+0.04}	3 ^{+0.2}	11	M5×0.8	10	17	5.5	6.6	11	8	78	6 ^{+0.04} _{-0.01}	6	40	M8×1.25	16	78	65 ^{+0.05}	2.5

Bore size\Item	O	OA	OB	P	PA	PB	R	UA	UB	T	TA	TB	V	VA	W	Z	ZA	ZB
32	M4×0.7	8	44	M5×0.8	10	19	76	15.5	11.5	9	15.5	2.5	62	55.5	14	5	7.4	6 ^{+0.048}
40	M4×0.7	8	52	M5×0.8	11	19	86	19	15	9	17.5	2.5	72	62.5	16	5	11.4	10 ^{+0.058}
50	M5×0.8	10	63	M5×0.8	11	26	103	24	18	10	21	3	84	74.5	18	6	13.4	12 ^{+0.07}
63	M6×1.0	12	78	M5×0.8	13	29	125	31	23	12	26	3	102	92.5	24	7	17.4	16 ^{+0.07}



Air gripper(parallel open/close hollow style)

HFCQ Series

HFCQ32E~63E

(With Cylinder push rod mechanism)

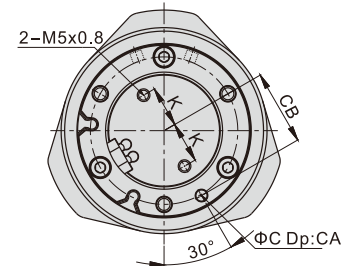
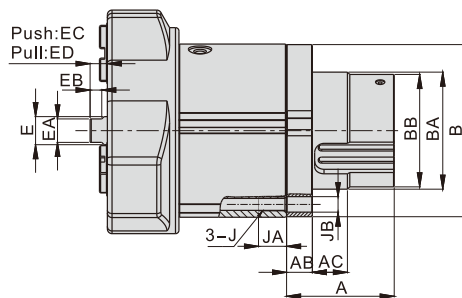
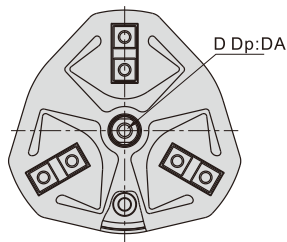
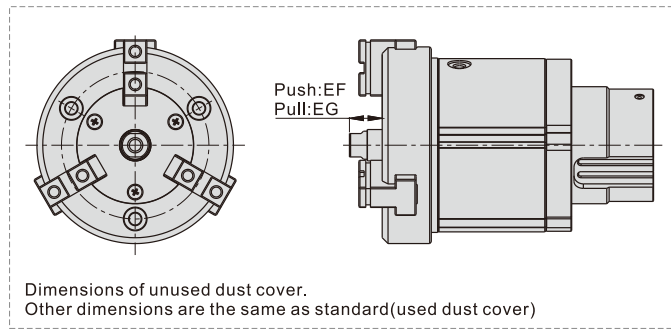

Bore size\Item	A	AB	AC	B	BA	BB	C	CA	CB	D	DA	E	EA	EB	EC	ED	EF	EG	J	JA	JB	K
32	36	9	9	54.5	32 ⁰ _{-0.05}	30	4 ^{+0.04} _{+0.01}	4	22	M3×0.5	6	6	5	3.5	14	7	20	13	M5×0.8	10	5.5	9.5
40	38	9	12	61.5	40 ⁰ _{-0.05}	38	4 ^{+0.04} _{+0.01}	4	26	M5×0.8	10	10	8	4.5	15	7	21	13	M5×0.8	10	5.5	13.5
50	48	11	15	73.5	50 ⁰ _{-0.05}	48	5 ^{+0.04} _{+0.01}	5	32	M6×1.0	12	12	10	5	21	7	28	14	M6×1.0	12	6.6	17.5
63	53	13	18	91.5	60 ⁰ _{-0.05}	58	6 ^{+0.04} _{+0.01}	6	40	M8×1.25	16	16	14	7	24	9	32	17	M8×1.25	16	8.6	20

HFCQ32C~63V

(With Spring push rod mechanism)

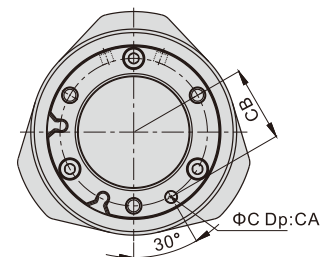
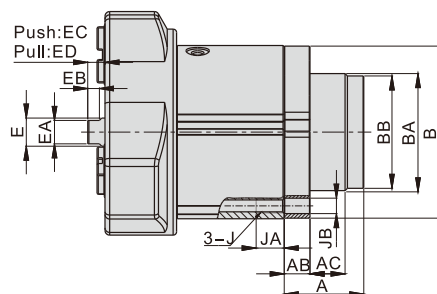
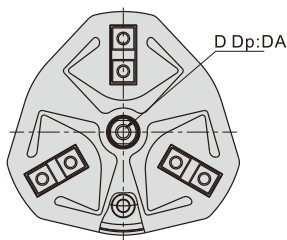
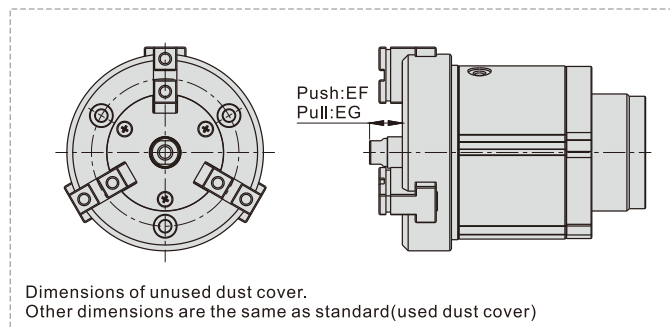

Bore size\Item	A	AB	AC	B	BA	BB	C	CA	CB	D	DA	E	EA	EB	EC	ED	EF	EG	J	JA	JB
32	20	9	11	54.5	32 ⁰ _{-0.05}	-	4 ^{+0.04} _{+0.01}	4	22	M3×0.5	6	6	5	3.5	14	7	20	13	M5×0.8	10	5.5
40	24	9	15	61.5	40 ⁰ _{-0.05}	-	4 ^{+0.04} _{+0.01}	4	26	M5×0.8	10	10	8	4.5	15	7	21	13	M5×0.8	10	5.5
50	34	11	15	73.5	50 ⁰ _{-0.05}	48	5 ^{+0.04} _{+0.01}	5	32	M6×1.0	12	12	10	5	21	7	28	14	M6×1.0	12	6.6
63	40	13	18	91.5	60 ⁰ _{-0.05}	58	6 ^{+0.04} _{+0.01}	6	40	M8×1.25	16	16	14	7	24	9	32	17	M8×1.25	16	8.6

HFCQ Series

How to select product

Please select pneumatic finger according to the following steps:

① The selection of the effective gripping force



② the confirmation of the gripping point

1. The selection of the gripping force

The gripping work-pieces shown below, on the impact condition of ordinary handling state, taking safety coefficient $a=4$, have a gripping force that is more than 10-20 times of the mass of the gripped objects.

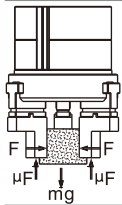

The work-pieces as shown in the left :

n: number of gripper
 F: Gripping force (N)
 μ : friction coefficient between fittings and work-pieces.
 m: mass of work-pieces
 g: acceleration of gravity ($=9.8m/s^2$)

The condition that the work-pieces won't drop is: $n \times \mu F > mg$

$$\text{so: } F > \frac{mg}{n \times \mu}$$

Safety coefficient is a, so F is:

$$F = \frac{mg}{n \times \mu} \times a$$

$$\mu = 0.2$$

$$F = \frac{mg}{2 \times 0.2} \times 4 = 10 \times mg$$

10 times of the mass of the gripped objects

$$\mu = 0.1$$

$$F = \frac{mg}{2 \times 0.1} \times 4 = 20 \times mg$$

20 times of the mass of the gripped objects

Note) If the friction coefficient $\mu > 0.2$, for safety, please also select clamping force according to the principle of 10~20 times of the mass of the clamped objects. As for large acceleration and shock, it requires for greater safety coefficient.

1.1) The actual gripping force must be within the effective gripping forces of different pneumatic fingers specifications shown in the below chart.

Opened gripping force

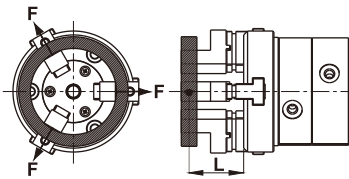

Closed gripping force

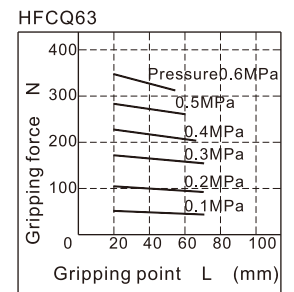
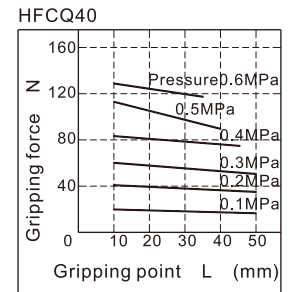
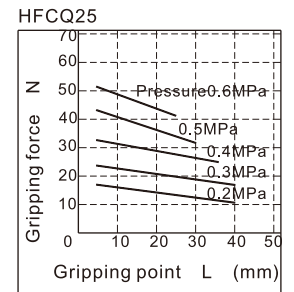
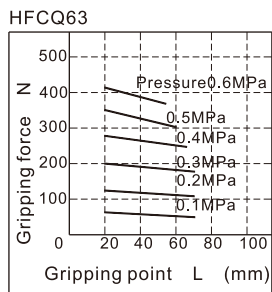
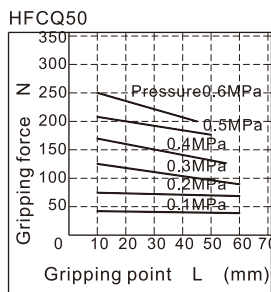
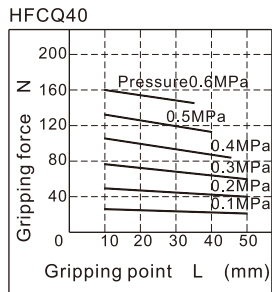
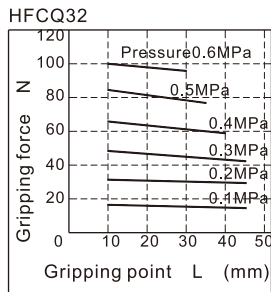
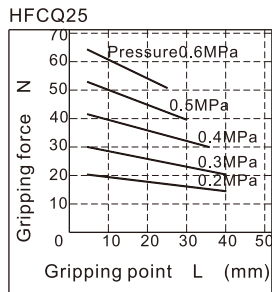
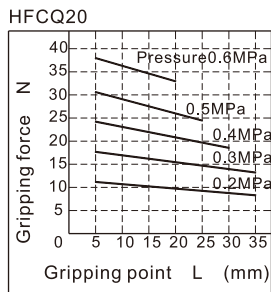
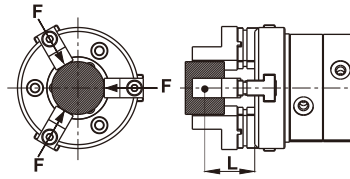

Air gripper(parallel open/close hollow style)

HFCQ Series

Effective thrust of Push rod mechanism

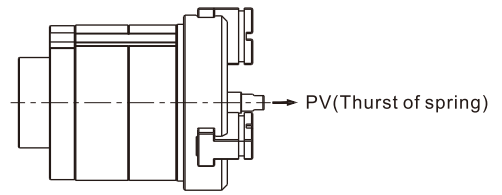
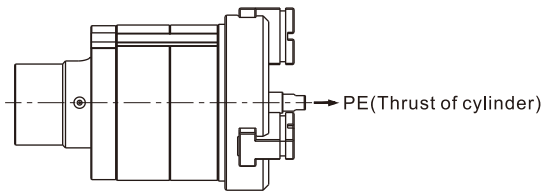

HFCQ32E

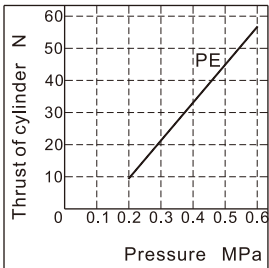

HFCQ50E

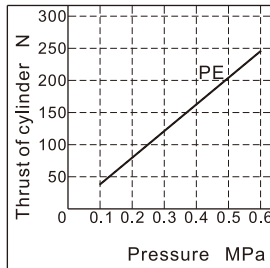

HFCQ32V

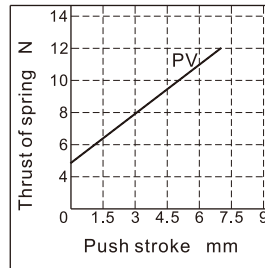

HFCQ50V

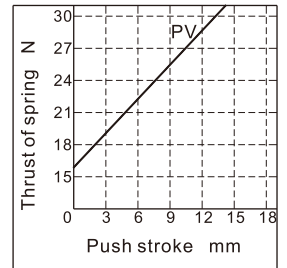

HFCQ40E

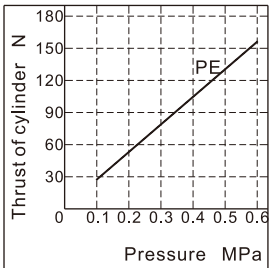

HFCQ63E

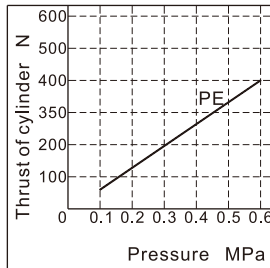

HFCQ40V

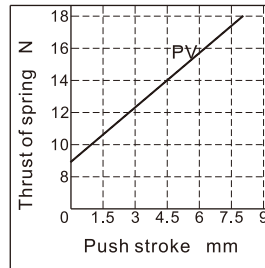

HFCQ63V

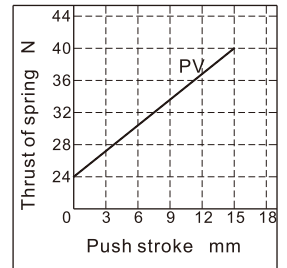

Air gripper(parallel open/close hollow style)

HFCQ Series

Installation and application

1. Due to the abrupt changes, the circuit pressure is low, which will lead to the decrease of the gripping force and falling of the work-pieces.
In order to avoid the harm to the human body and damage to the equipment, anti-dropping device must be equipped.
2. Don't use the air gripper under strong external force and impact force.
3. When install and fix the air gripper, avoid falling down, collision and damage.
4. When fixing the gripping jaw parts, don't twist the gripping jaw.
5. There are several kinds of installation method, and the locking torque of fastening screw must be within the prescribed torque range shown in the below chart.
If the locking torque is too large, it will cause the dysfunctional. If the locking torque is too small, it will cause the position deviation and fall.

Tail installation type

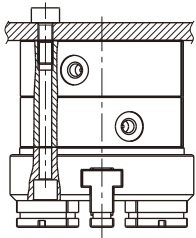

Bore size	The bolts type	Max. locking moment(N.m)	Max. screwed depth(mm)	The aperture of the positioning bore(mm)	The depth of the positioning bore(mm)
16	M4 × 0.7	2.1	8	Φ 17 ^{+0.05} ₀	1.5
20	M4 × 0.7	2.1	8	Φ 21 ^{+0.05} ₀	1.5
25	M4 × 0.7	2.1	8	Φ 26 ^{+0.05} ₀	1.5
32	M4 × 0.7	2.1	8	Φ 34 ^{+0.05} ₀	2
	M5 × 0.8	4.3	10	Φ 34 ^{+0.05} ₀	2
40	M4 × 0.7	2.1	8	Φ 42 ^{+0.05} ₀	2
	M5 × 0.8	4.3	10	Φ 42 ^{+0.05} ₀	2
50	M5 × 0.8	4.3	10	Φ 52 ^{+0.05} ₀	2
	M6 × 1.0	7.3	12	Φ 52 ^{+0.05} ₀	2
63	M6 × 1.0	7.3	12	Φ 65 ^{+0.05} ₀	2.5
	M8 × 1.25	18	16	Φ 65 ^{+0.05} ₀	2.5

The installation of the front through hole

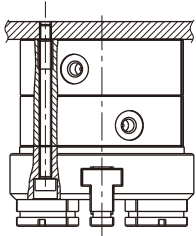

Bore size	The bolts type	Max. locking mement(N.m)
16	M3×0.5	0.88
20	M3×0.5	0.88
25	M3×0.5	0.88
32	M4×0.7	2.1
40	M4×0.7	2.1
50	M5×0.8	4.3
63	M6×1.0	7.3

The installation of the front through hole(with push rod)

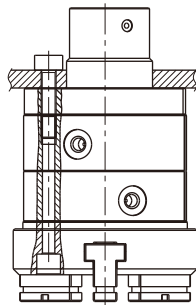

Bore size	The bolts type	Max. locking moment(N.m)	Max. screwed depth(mm)	The aperture of the positioning bore(mm)
32	M5×0.8	4.3	10	Φ32 ⁰ _{-0.05}
40	M5×0.8	4.3	10	Φ40 ⁰ _{-0.05}
50	M6×1.0	7.3	12	Φ50 ⁰ _{-0.05}
63	M8×1.25	18	16	Φ60 ⁰ _{-0.05}

Tail installation type(with push rod)

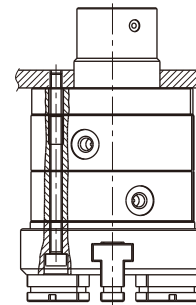

Bore size	The bolts type	Max. locking mement(N.m)
32	M4×0.7	2.1
40	M4×0.7	2.1
50	M5×0.8	4.3
63	M6×1.0	7.3

6. The installation method of the gripping jaw fittings

When install the gripping jaw fittings, you have to pay particular attention that you can only hold the gripping jaw by using spanner, and then lock the screws with allen wrench. Never clamp the body directly and then lock the screws, otherwise the parts will be easily damaged.

Install the gripping jaw fittings

Bore size	The bolts type	Max. locking mement(N.m)
16	M3×0.5	0.59
20	M3×0.5	0.59
25	M3×0.5	0.59
32	M4×0.7	1.4
40	M4×0.7	1.4
50	M5×0.8	2.8
63	M5×0.8	2.8

