



Rotary clamp cylinder—QCK Series

Compendium of QCK Series

Dustproof and welding slag out design

The front cover with stainless steel dust scraping ring, can keep the dust and welding slag out, and protect cylinder internal parts.

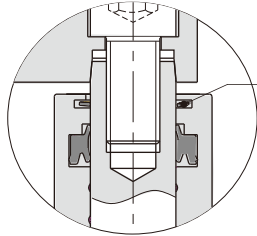

Stainless steel dust scraping ring

Two kinds of rod type

Taper type
(with clamp arm)

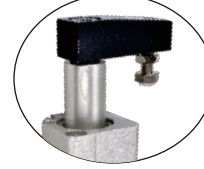

Across flat position rod type
(without clamp arm)



Be used on welding fixture

It can be used on welding fixture, the QPQ surface treatment prevent piston rod damage by welding slag; better than chrome plated piston rod.

Better commonness

The mounting dimension of body is the same as ACQ series, can use ACQ series' accessories.

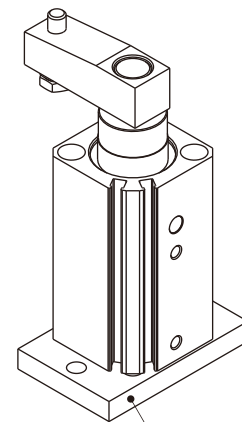

ACQ series' accessories

Magnetic switch slots around the cylinder body

There are magnetic switch slots around the cylinder body convenient to install inducting switch.

Criteria for selection: Cylinder thrust

Unit: Newton(N)

Bore size	Rod size	Acting type	Operating pressure(MPa)							
			0.1	0.2	0.3	0.4	0.5	0.6	0.7	0.8
12	6	IN(Clamp)	8.5	17.0	25.4	33.9	42.4	50.9	59.4	67.9
		OUT(Release)	11.3	22.6	33.9	45.2	56.5	67.9	79.2	90.4
16	8	IN(Clamp)	15.1	30.2	45.2	60.3	75.4	90.5	105.6	120.6
		OUT(Release)	20.1	40.2	60.3	80.4	100.5	120.6	140.7	160.8
20	12	IN(Clamp)	20.1	40.2	60.3	80.4	100.5	120.6	140.7	160.8
		OUT(Release)	31.4	62.8	94.2	125.7	157.1	188.5	219.9	251.3
25	12	IN(Clamp)	37.8	75.6	113.3	151.1	188.9	226.7	264.4	302.2
		OUT(Release)	49.1	98.2	147.3	196.3	245.4	294.5	343.6	392.7
32	16	IN(Clamp)	60.3	120.6	181.0	241.3	301.6	361.9	422.2	482.5
		OUT(Release)	80.4	160.8	241.3	321.7	402.1	482.5	563.0	643.4
40	16	IN(Clamp)	105.6	211.1	316.7	422.2	527.8	633.3	738.9	844.5
		OUT(Release)	125.7	251.3	377.0	502.7	628.3	754.0	879.6	1005.3
50	20	IN(Clamp)	164.9	329.9	494.8	659.7	824.7	989.6	1154.5	1319.5
		OUT(Release)	196.3	392.7	589.0	785.4	981.7	1178.1	1374.4	1570.8
63	20	IN(Clamp)	280.3	560.6	840.9	1121.2	1401.5	1681.9	1962.2	2242.5
		OUT(Release)	311.7	623.4	935.2	1246.9	1558.6	1870.3	2182.1	2493.8

Installation and application



1. Dirty substances in the pipe must be eliminated before cylinder is connected with pipeline to prevent the entrance of impurities into the cylinder.
2. The medium used by cylinder shall be filtered to 40μm or below.
3. Anti-freezing measure shall be adopted under low temperature environment to prevent moisture freezing.
4. If the cylinder is dismantled and stored for a long time, please conduct anti-rust treatment to the surface. Anti-dust jam cap shall be added in air inlet and outlet ports.
5. To insure the life-span of cylinder and jig, please use flow control valve to control the speed of cylinder.



Rotary clamp cylinder

QCK Series



Specification

Bore size(mm)	12	16	20	25	32	40	50	63	
Acting type	Double acting								
Fluid	Air(to be filtered by 40µm filter element)								
Operating pressure	0.15~1.0MPa(22~145psi)(1.5~10bar)								
Proof pressure	1.5MPa(215psi)(15bar)								
Temperature	-20~70°C								
Speed range	50~200mm/s								
Rotation angle	90°								
Repeatability	± 2°								
Rotation direction	Turn left or turn right								
Rotation stroke(mm)	7.5		9.5		15		19		
Clamping stroke (mm)	10	20	10	20	30	10	20	30	50
Stroke tolerance	+1 0								
Cushion type	Bumper								
Port size [Note1]	M5×0.8				1/8"		1/4"		

[Note1] G thread is available.
Add) QCK series are all attached with magnet, please refer to Page 519 for the specific content of sensor switch.

Symbol

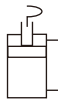

Product feature

1. It can be used on welding fixture, the QPQ surface treatment prevent piston rod damage by welding slag; better than chrome plated piston rod.
2. The front cover with stainless steel dust scraping ring, can keep the dust and welding slag out, and protect cylinder internal parts.
3. The mounting dimension of body is the same as ACQ series, can use ACQ series' accessories.

Ordering code

QCK L 32 × 10 S M FB G

① ② ③ ④ ⑤ ⑥ ⑦ ⑧

① Model	② Rotation direction	③ Bore size	④ Clamping stroke	⑤ Magnet	⑥ Rod type	⑦ Mounting type [Note1]	⑧ Thread type [Note2]
QCK: Rotary clamp cylinder	L: Push and turn left R: Push and turn right	12	10 20	S: With magnet M: Across flat position type(without clamp arm)	Blank: Taper type (with clamp arm) M: Across flat position type(without clamp arm)	Blank: No bracket FB: FB type	G: G
		16	10 20 30				
		20					
		25					
		32	10 20 30 50				
		40					
50							
63							

[Note1] Back flange is same as ACQ series (please refer right table), if need front flange, please contact us.

[Note2] When the thread is standard, the code is blank.

Bore size/Accessories	FB	Material	Bore size/Accessories	FB	Material
12	F-ACQ12FA	Aluminum alloy	32	F-ACQ32FA	Aluminum alloy
16	F-ACQ16FA		40	F-ACQ40FA	
20	F-ACQ20FA		50	F-ACQ50FA	
25	F-ACQ25FA		63	F-ACQ63FA	

The definition of rotation direction and angle

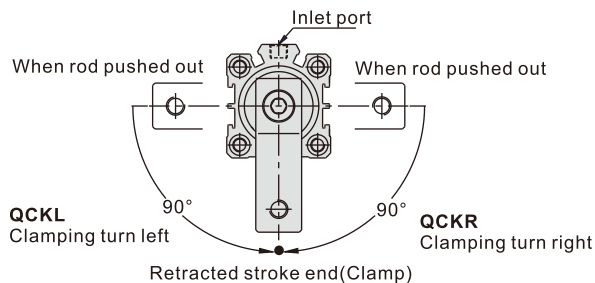

Lavorotary(QCKL):
When the piston of cylinder moves downward, the swivel arms moves anticlockwise, this is called lavorotary.

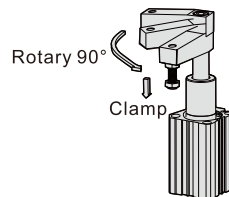

The order code is L

Dextrorotary(QCKR):
When the piston of cylinder moves downward, the swivel arms moves clockwise, this is called dextrorotary.

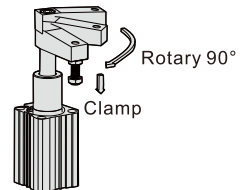

The order code is R

Rotary clamp cylinder

QCK Series

Inner structure and material of major parts

NO.	Item	Material	NO.	Item	Material
1	Rocker	Carbon steel	14	Magnet washer	NBR
2	Screw	Carbon steel	15	Magnet	Sintered metal (Neodymium-iron-boron(Φ12~Φ25))
3	Dust scraping ring	No(Φ12, Φ16) Stainless steel(Others)			Plastic(Others)
4	Front cover packing	NBR	16	Piston seal	NBR
5	Piston rod	Scr440	17	Back cover	Aluminum alloy
6	Front cover	Aluminum alloy	18	Bumper	TPU(Φ12~Φ25)\NBR(Others)
7	C Clip	Spring steel	19	Wear ring	No(Φ12~Φ32) Wear resistant material(Others)
8	Screw	Carbon steel			Brass(Φ12, Φ16) Aluminum alloy(Others)
9	Operating screw	Scr440	20	Piston	Brass(Φ12, Φ16) Aluminum alloy(Others)
10	O-ring	NBR	21	Screw	Carbon steel
11	O-ring	NBR			22
12	Body	Aluminum alloy	23	Bumper	PTFE(Φ12~Φ40)\POM(Others)
13	Magnet holder	Brass(Φ12, Φ16) Aluminum alloy(Others)			

Dimensions

QCK□ (Taper type with clamp arm)

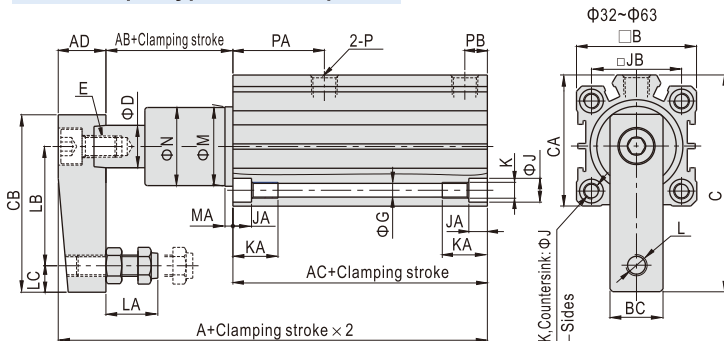

Bore size/Item	A	AB	AC	AD	B	BC	C	CA	CB	D
12	55	10.5	35.5	9	25	9	36.5	-	29	6
16	59	10.5	35.5	13	29	11	44.5	-	36	8
20	86	8	62	16	36	16	60	-	51	12
25	87	8	63	16	40	16	62	-	51	12
32	108	17.5	71.5	19	45	19	82	49.5	67	16
40	109	25	65	19	53	19	85.5	57	67	16
50	133	31	76.5	25.5	64	25.5	114	71	88	20
63	136	30.5	80	25.5	77	25.5	120.5	84	88	20

Bore size/Item	E	G	J	JA	JB	JC	K
12	M3×0.5	3.3	6	3.5	15.5	22	M4×0.7
16	M5×0.8	3.3	6	3.5	20	28	M4×0.7
20	M8×1.25	5	9	5.5	25.5	36	M6×1.0
25	M8×1.25	5	9	5.5	28	40	M6×1.0
32	M10×1.5	5	9	5.5	34	-	M6×1.0
40	M10×1.5	5	9	5.5	40	-	M6×1.0
50	M12×1.75	6.5	10.5	6.5	50	-	M8×1.25
63	M12×1.75	8.5	14	9	60	-	M10×1.5

Bore size/Item	KA	L	LA	LB	LC	M	MA	N	P	PA	PB
12	11	M4×0.7	7~13	20	4	11	3	10.8	M5×0.8	13.5	5.5
16	11	M4×0.7	7~13	25	5	14	3	13.8	M5×0.8	15	5.5
20	17	M6×1.0	9.5~20.5	35	7	18	3	17.8	M5×0.8	30	6
25	17	M6×1.0	9.5~20.5	35	7	23	6	22.5	M5×0.8	30	7
32	17	M8×1.25	13.5~25.5	45	10	30	7	29.5	1/8"	34.5	8.5
40	17	M8×1.25	13.5~25.5	45	10	30	3	29.5	1/8"	26.5	9
50	22	M10×1.5	14.5~30	65	10	37	3.5	36.5	1/4"	34	11.5
63	28.5	M10×1.5	14.5~30	65	10	48	3.5	47.5	1/4"	34.5	11.5

QCK□M (Across flat position type without clamp arm)

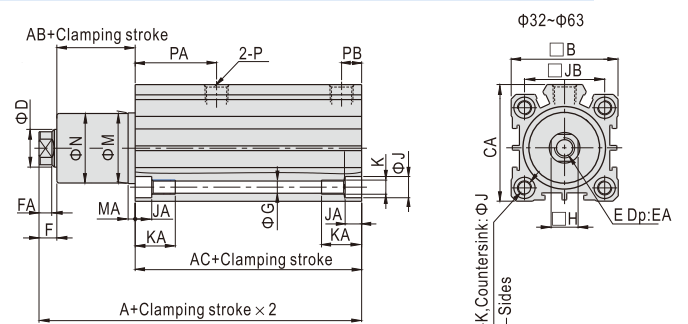

Bore size/Item	A	AB	AC	B	CA	D	F	FA
12	48	9.5	35.5	25	-	6	3	2.5
16	48	9.5	35.5	29	-	8	3	2.5
20	72.5	6.5	62	36	-	12	4	3
25	73.5	6.5	63	40	-	12	4	3
32	93.5	15.5	71.5	45	49.5	16	6.5	5.5
40	94.5	23	65	53	57	16	6.5	5.5
50	112	28	76.5	64	71	20	7.5	5.5
63	115	27.5	80	77	84	20	7.5	5.5

Bore size/Item	H	E	EA	G	J	JA
12	5	M3×0.5	6	3.3	6	3.5
16	7	M5×0.8	7	3.3	6	3.5
20	10	M8×1.25	13	5	9	5.5
25	10	M8×1.25	13	5	9	5.5
32	14	M10×1.5	15	5	9	5.5
40	14	M10×1.5	15	5	9	5.5
50	17	M12×1.75	20	6.5	10.5	6.5
63	17	M12×1.75	20	8.5	14	9

Bore size/Item	JB	JC	K	KA	M	MA	N	P	PA	PB
12	15.5	22	M4×0.7	11	11	3	10.8	M5×0.8	13.5	5.5
16	20	28	M4×0.7	11	14	3	13.8	M5×0.8	15	5.5
20	25.5	36	M6×1.0	17	18	3	17.8	M5×0.8	30	6
25	28	40	M6×1.0	17	23	6	22.5	M5×0.8	30	7
32	34	-	M6×1.0	17	30	7	29.5	1/8"	34.5	8.5
40	40	-	M6×1.0	17	30	3	29.5	1/8"	26.5	9
50	50	-	M8×1.25	22	37	3.5	36.5	1/4"	34	11.5
63	60	-	M10×1.5	28.5	48	3.5	47.5	1/4"	34.5	11.5

Rotary clamp cylinder

QCK Series

QCK-FB(With flange)

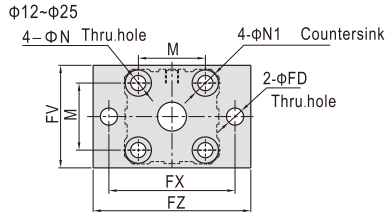
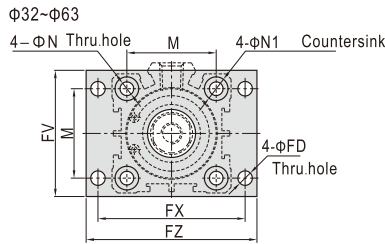

QCK□-FB(Taper type with clamp arm)

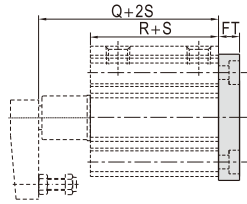

QCK□M-FB(Across flat position rod without clamp arm)

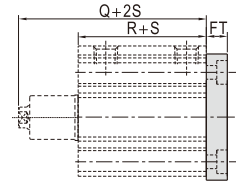

Bore size\Item	R	Q(QCK□)	Q(QCK□M)	M	N	N1	FD	FT	FV	FX	FZ
12	35.5	46	48	15.5	4.5	7.5	4.5	5.5	25	45	55
16	35.5	46	48	20	4.5	7.5	4.5	5.5	30	45	55
20	62	70	72.5	25.5	6.5	10.5	6.5	8	39	48	60
25	63	71	73.5	28	6.5	10.5	6.5	8	42	52	64
32	71.5	89	93.5	34	6.5	10.5	5.5	8	48	56	65
40	65	90	94.5	40	6.5	10.5	5.5	8	54	62	72
50	76.5	107.5	112	50	8.5	13.5	6.5	9	67	76	89
63	80	110.5	115	60	10.5	16.5	9	9	80	92	108

Installation and operation

- To insure the life-span of cylinder and jig, please use flow control valve to control the speed of cylinder.
- The method of installation are mounted by flange on top or bottom.
- Before the cylinder is connected to pipeline sundries in the pipe must be eliminated, or may cause leakage.
- Please clean the piston-rod and dust scraping ring to protect the cylinder.
- The cylinder using normal magnet ring can use the same sensor as ACQ series. For the cylinder using strong magnet ring we suggest using AirTAC's CS1-69AM sensor.
- Because the rotary force is strong when the cylinder's acting, we suggest using flow control valve to control the speed to protect cylinder.
- Please install the cylinder following the right diagram.
- The installation method as the diagram below is wrong, and will injure the cylinder and shorten the cylinder life.

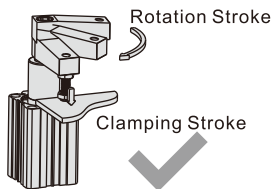

Only can clamping in clamping stroke.

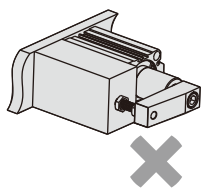
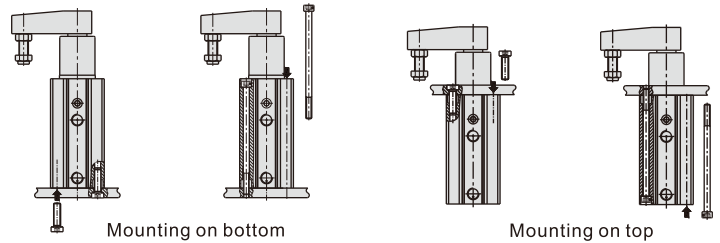

Don't installed horizontally

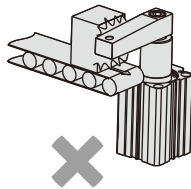

Don't exert horizontally load or force

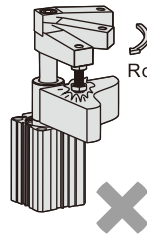

Please don't clamp when rotating.

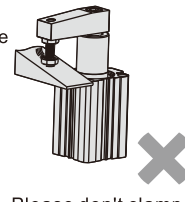

Please don't clamp on bevel

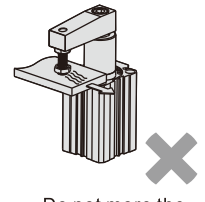

Do not more the workpiece when clamped

9. Rocker

- The design of rocker can keep it stable and can change direction by customer.
- Please follow the diagram below on right side to assemble/disassemble the rocker by spanner and allen wrench; don't hold the body to assemble/disassemble rocker, or will damage the cylinder.
- If need customize rocker, please contact us.

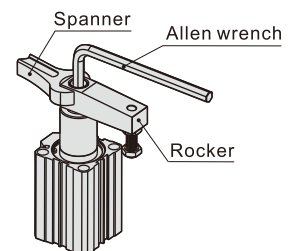
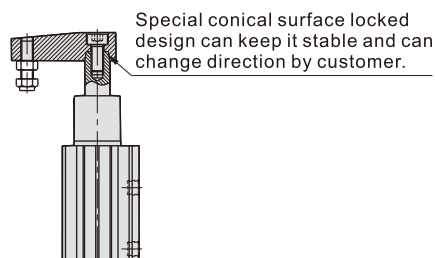

Rotary clamp cylinder

QCK Series

How to select product

- When arms are to be made separately, their length and weight should be within the following range.
- Allowable bending moment:
Use the arm length and operating pressure within graph(1) for allowable bending moment loaded piston rod.

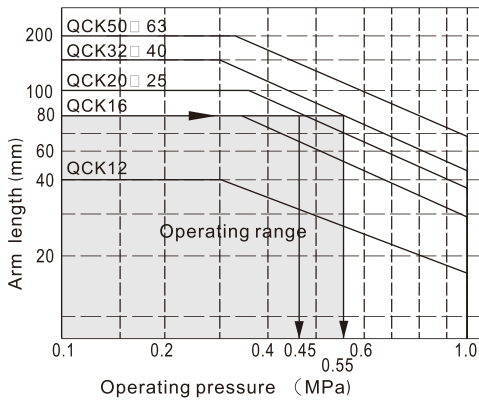

Example: When arm length is 80mm, pressure should be less than
 QCK20/25:0.45MPa
 QCK32/40:0.55MPa

- Moment of inertia:
When the arm is long and heavy, damage of internal parts may be caused due to inertia. Use the inertia moment and cylinder speed within graph(2) based on arm requirements.

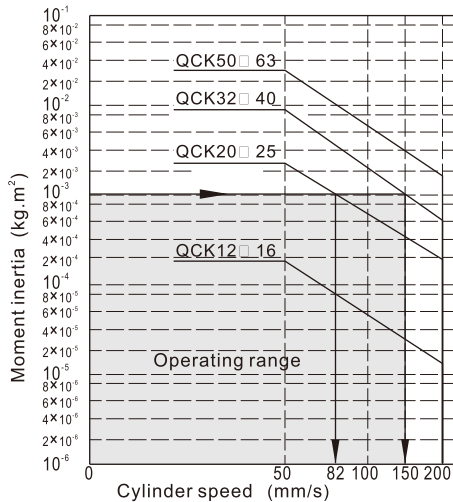

Example: When arm's moment of inertia is $10^{-3} \text{Kg}\cdot\text{m}^2$, cylinder speed should be less than
 QCK20/25:82mm/s
 QCK32/40:150mm/s

Note) The average speed of piston=the highest speed of piston/1.6

- Moment of inertia of cylinder's arm when rotating based on its rotary axis, shown in graph(3).

Model	Moment of inertia(Kg·m ²)
QCK12	3.555×10^{-5}
QCK16	1.053×10^{-5}
QCK20/25	5.257×10^{-5}
QCK32/40	1.653×10^{-4}
QCK50/63	7.387×10^{-4}

- Calculation reference □
 5.1)Moment of inertia of arm (I₁) : Refer to the graph(3) after the cylinder bore diameter is determined.

- 5.2)Moment of inertia of jig (I₂) : According to shape of the jig and the next item 6 "Calculation for moment of inertia", pick out a proper formula for calculation.

The jig shown on the right graph is a cylinder ,its formula of moment of inertia is:

$$I_2 = (m_2 * D * D) / 8 + m_2 * L * L$$

When QCK32 is selected: L=0.045m (arm length);

If D=0.04m $m_2=0.4\text{kg}$

From graph(3): $I_1 = 1.653 \times 10^{-4} (\text{Kg}\cdot\text{m}^2)$

By Calculation : $I_2 = (m_2 * D * D) / 8 + m_2 * L * L = 0.4 * 0.04 * 0.04 / 8 + 0.4 * 0.045 * 0.045 = 8.9 \times 10^{-4} (\text{Kg}\cdot\text{m}^2)$

Total value: $I = I_1 + I_2 = 10.553 \times 10^{-4} = 1.0553 \times 10^{-3} (\text{Kg}\cdot\text{m}^2)$

According to graph(2), the highest speed of the cylinder should be less than 150 mm/s;

According to graph(1), it can be used under a pressure of 0.9Mpa. The average speed of piston=the highest speed of piston/1.6=94 mm/s.

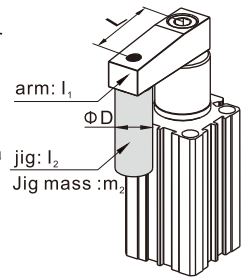

- Calculation for moment of inertia

Diagram	Calculation formula of moment of inertia
1. Thin bar Position of rotary axis: Vertical to the bar and through the end 	$I = \frac{m_1 a_1^2 + m_2 a_2^2}{3}$
2. Thin bar Position of rotary axis: Vertical to the bar and through the center of gravity 	$I = \frac{m a^2}{12}$
3. Load at the end of lever arm 	$I = m_1 \times \frac{a_1^2}{3} + m_2 \times a_2^2 + k$ $k = m_2 \times \frac{2r^2}{5}$
4. Thin rectangular plate (Rectangular parallelepiped) Position of rotary axis: Parallel to side b and through the center of gravity 	$I = \frac{m a^2}{12}$
5. Thin rectangular plate (Rectangular parallelepiped) Position of rotary axis: Vertical to the plate and through the end 	$I = m_1 \times \frac{4a_1^2 + b^2}{12} + m_2 \times \frac{4a_2^2 + b^2}{12}$
6. Thin rectangular plate (Rectangular parallelepiped) Position of rotary axis: Through the center of gravity and vertical to the plate (Same as also thick rectangular plate) 	$I = \frac{m a^2 + m b^2}{12}$